

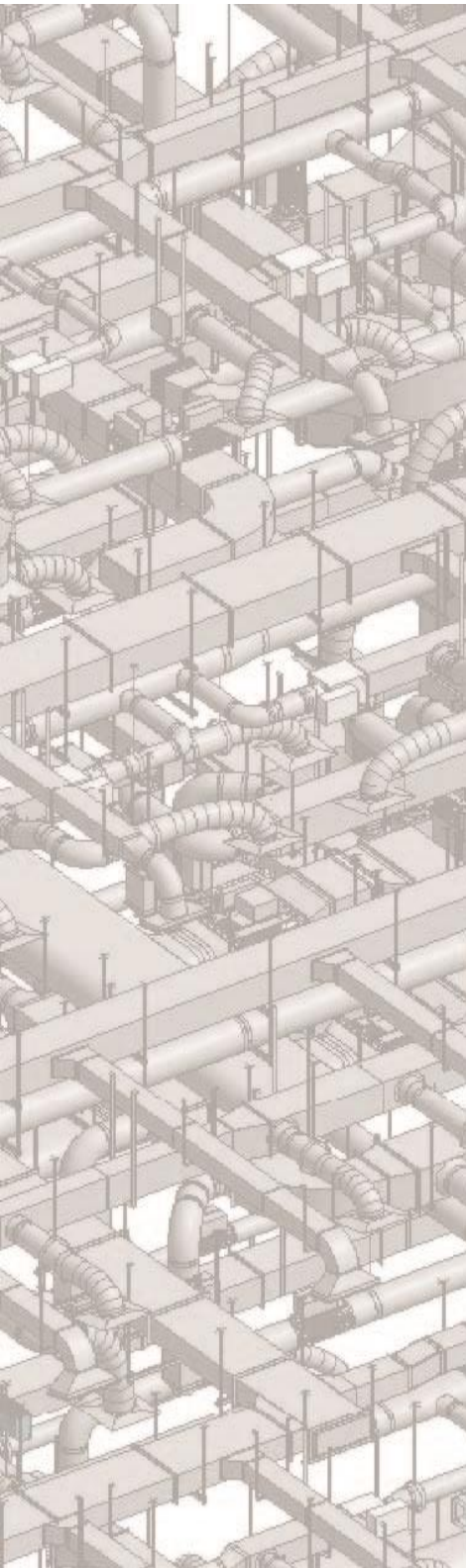

SysQue[®]
the difference is **REAL**[™]



Systems Pipe

Summary

Learn to utilize Systems Pipe for Revit 2016.

Contents

Introduction

[SysQue Systems Pipes](#)

[SysQue Systems Pipes Menu](#)

[Modeling Using Systems Pipe](#)

Introduction

[In this document, users will learn](#) how to utilize SysQue Systems Pipe, and how to draw Pipe into their projects.

SysQue Systems Pipe

1 SysQue Systems Pipe is located in the last panel.

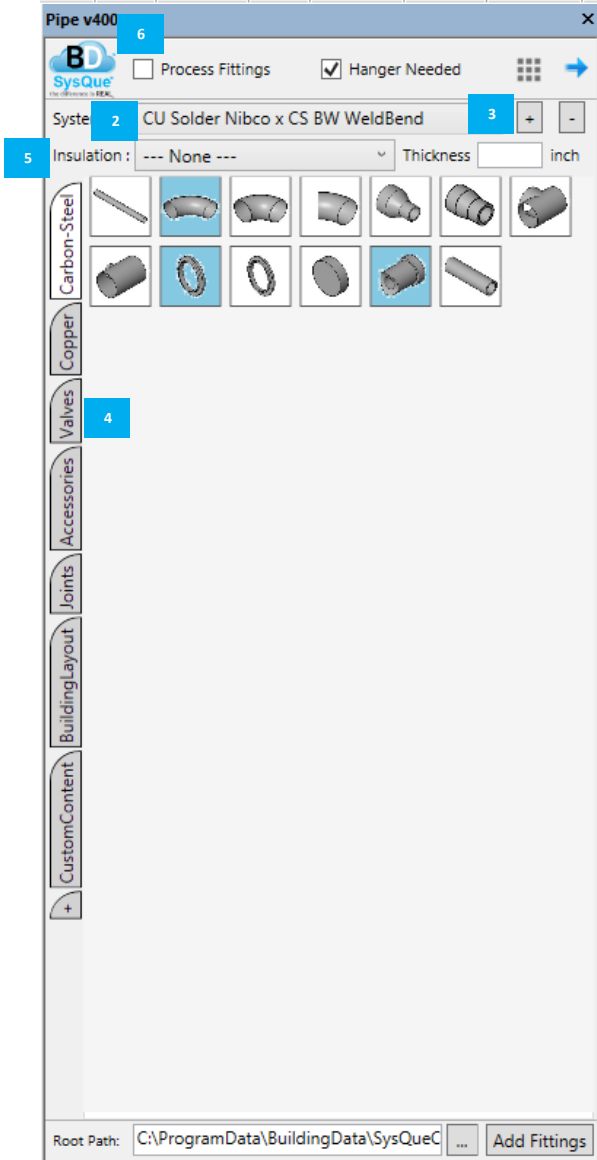
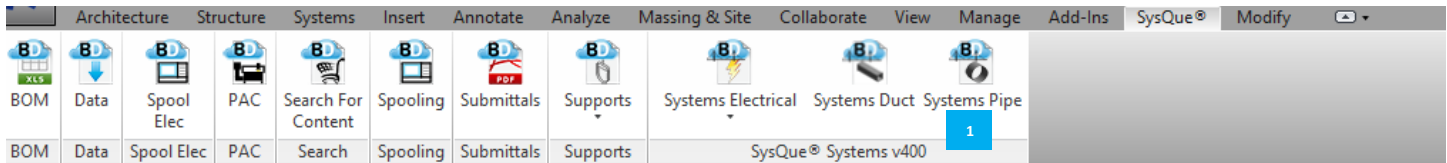

2 To view the list of available systems from the list, simply click on that system. CU Solder Nibco x CS BW Weldbend will be our example here.

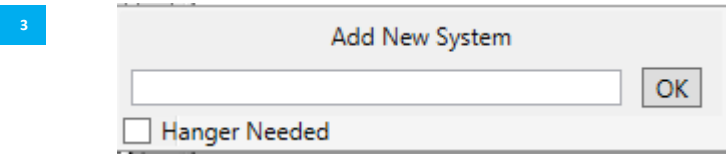

To add a new system, click on the + box. Check the 'Hanger Needed' Box if a hanger is needed. Inversely, clicking the – box will delete the currently selected System.

4 Tabs along the left side each contain their own set of buttons. It will simulate the items available in that system i.e. copper, valves, accessories, etc.

5 Insulation can be added by using the drop-down menu.

6 Process Fittings Only. When checked, SysQue will not cut the duct into full lengths.

NOTE: When checked, the duct is left in a “design” state, meaning it is represented as one long, continuous straight duct. This simplifies and speeds up the design process, while also allowing for changes to be made more quickly. The straight duct is split into standard lengths as the final step after you have completed your HVAC model.

SysQue Systems Pipe Menu

For this section, we will go over each SysQue Systems Pipe menu item in order from left to right, up to down.

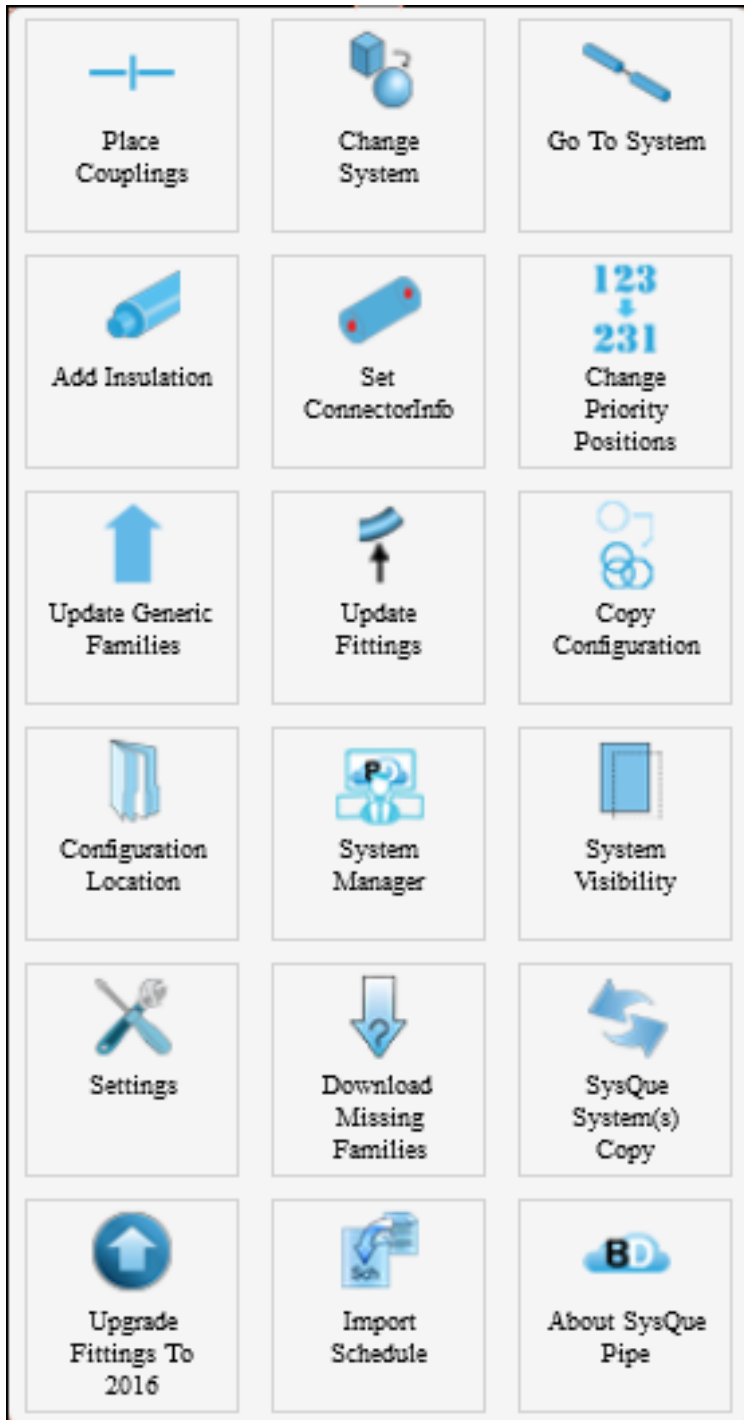

Place Couplings – Clicking this will allow you to break up a run of pipe into standard lengths. By default, when placing a run of pipe, couplings are automatically placed.

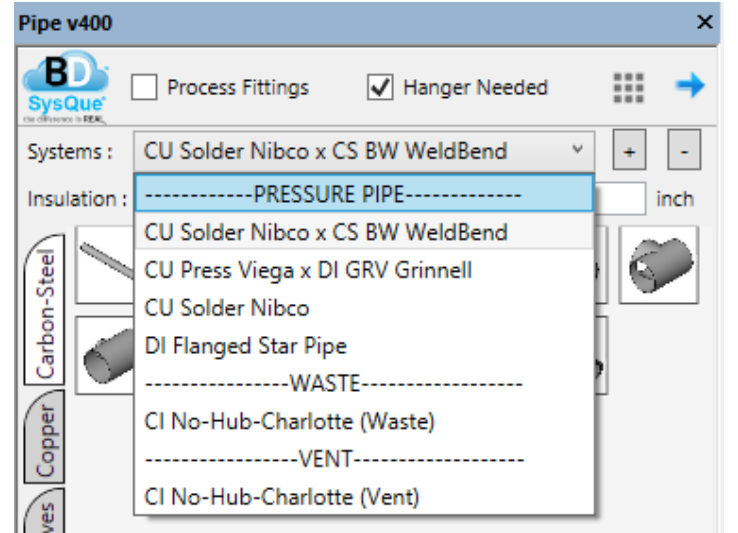

Change System - If you placed pipe in your model using the incorrect system, you can change the system using this option.

1. Select the pipe in your model.
2. Go to the Systems drop down box and select the system you want to change your existing pipe to.
3. Click on the Change System menu item at the top.

Add Insulation – This command will place insulation on selected systems. Simply choose your thickness and type.

Set Connector Info – This utility should be run after completion of installation and creating custom systems. This will load the proper connection information into SysQue® so that the processing of SysQue® will keep the connection upon processing. Also, if this needs to be ran you will receive a popup stating “Please Run Connector Info Utility”.

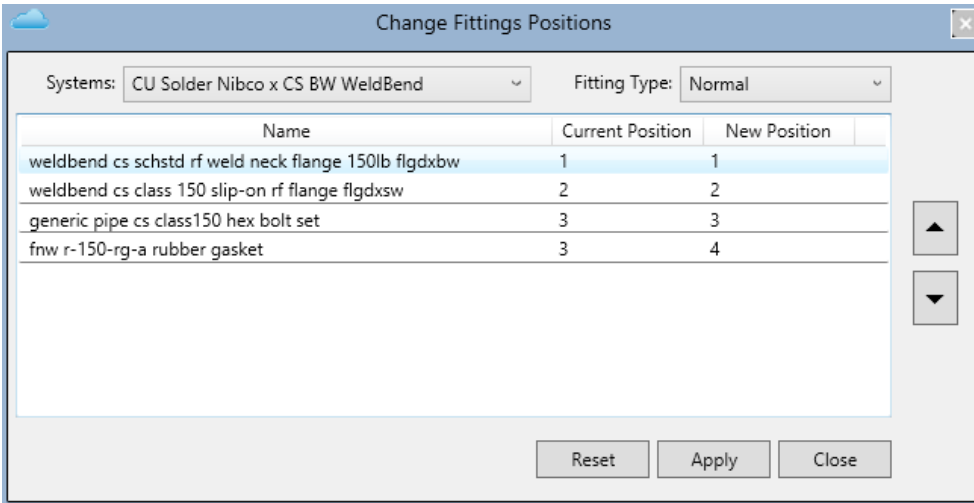

Change Priority Positions – This option gives you the ability to change the priority of fittings. By selecting which system, shape, and fitting type you want to change the position of. IE If you have a round bend you would like to use, you would move the position of this bend to position 1. This will tell SysQue to use this fitting first. Keep in mind if you have set a fitting as “Default” this will take precedence over this utility.

Update Generic Families – This option will download and update your system with the latest SysQue Generic fittings. Generic fittings are also versioned now. The system will look at your system and if it needs them to be update it will also ask.

Copy Configuration – This option allows the user to build custom systems and share their xml (Which holds your systems information) with other SysQue® users in their company. Simply select Copy xml and a Browse for folder box comes up. From here you select location to save. When complete a window pops up confirming the xml saved. Other users in your company can then place the xml in the following location: C:\ProgramData\BuildingData\Support\

Configuration Location – This option allows the user to place their Custom XML onto a network location, so that all users are pointing to the same systems. Any additions will update all users at once.

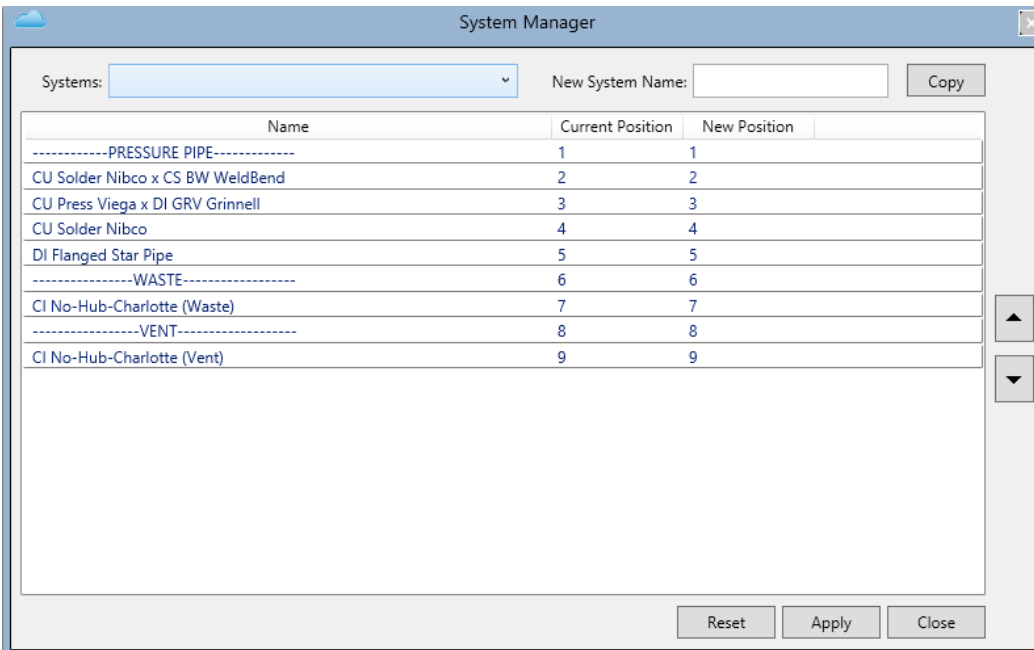

System Manager – This gives you the ability to rearrange your Pipe Systems in the SysQue Pipe Systems drop down. This helps when you have created your own systems and would like them to be organized. Simply load the System manager. Find the Pipe System you would like to move and select the up arrow until you find the desired spot. Select “Apply” and then close System Manager. You can also copy created systems by selecting the system, choosing another name and selecting copy.

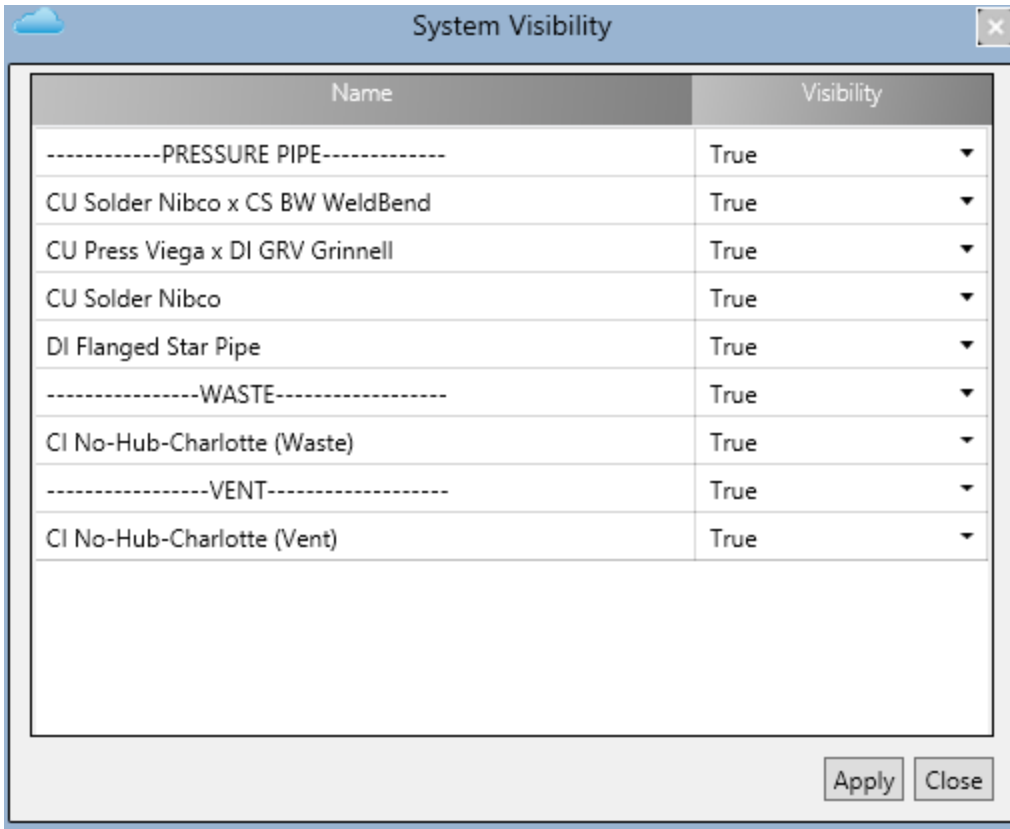

System Visibility – This option gives you the ability to “hide” a system or systems you do not want to use or show up in the SysQue Systems Drop down. Simply select the system you do not want to show up and change the Visibility to “FALSE”. When finished choosing what systems you do not want, click Apply then close. You will then notice the Systems do not show up in the Systems drop down menu.

Settings - This feature allows the user to customize key commands to your certain SysQue® commands, allowing users the ability to work faster by utilizing key commands as well.

Download Missing Families – This will download unreferenced families. While this will usually prompt when opening a system in SysQue, you can also access this on the menu if you have changed your families without rebooting the System.

SysQue System(s) Copy – Import a new system or Export the current SysQue system you are using currently into your folder structure.

Upgrade Fittings to 2016 – Upgrade your current fittings to the latest 2016 version since you can bring in your previous systems from 2015.

Import Schedule – Import a schedule from .xls or Excel format. To do so, you’ll need to export a Revit Schedule, save it in excel format, and then the import schedule function will allow you to import it into Revit.

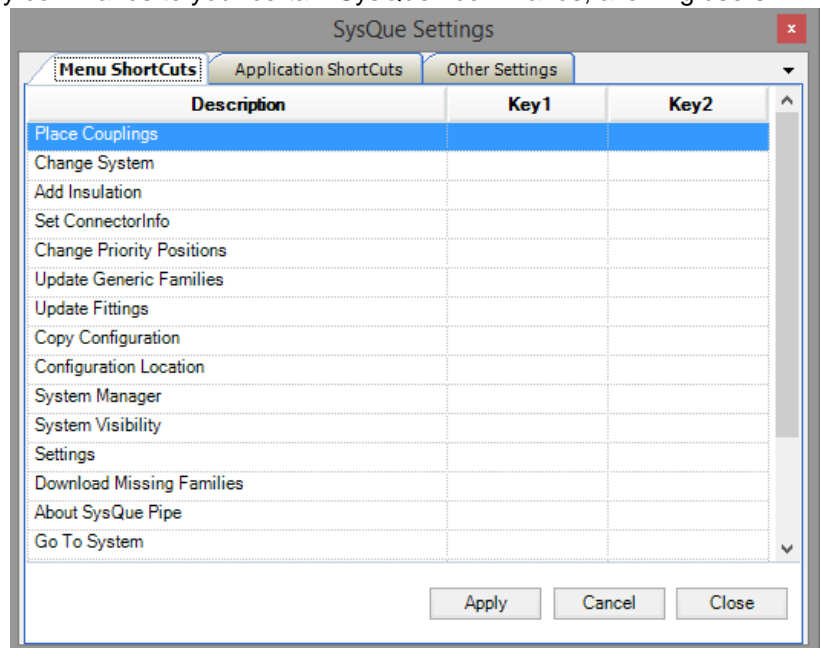

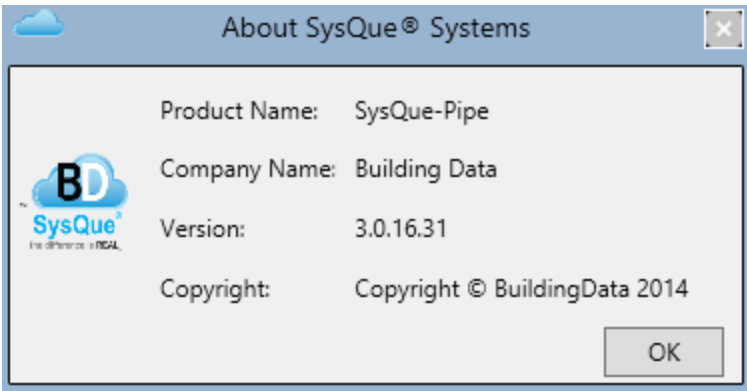

About SysQue® Pipe - Clicking on this brings up the “About SysQue® Systems” window, which lists, among other things, the SysQue® System Pipe version number. Click OK to close this window.

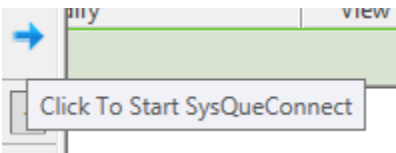

SysQue Connect – You can find this button next to the menu. It allows you to insert fitting to fitting and add rotational angles to your placement. Find more information about this in the next section.

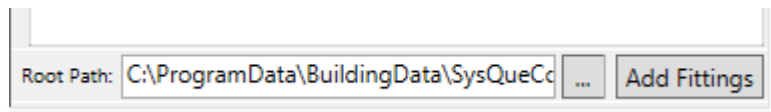

Adding Fittings - In the event that you are missing fittings or wish to import them over, you can ‘Add Fittings,’ which is located at the bottom of your Pipe Panel.

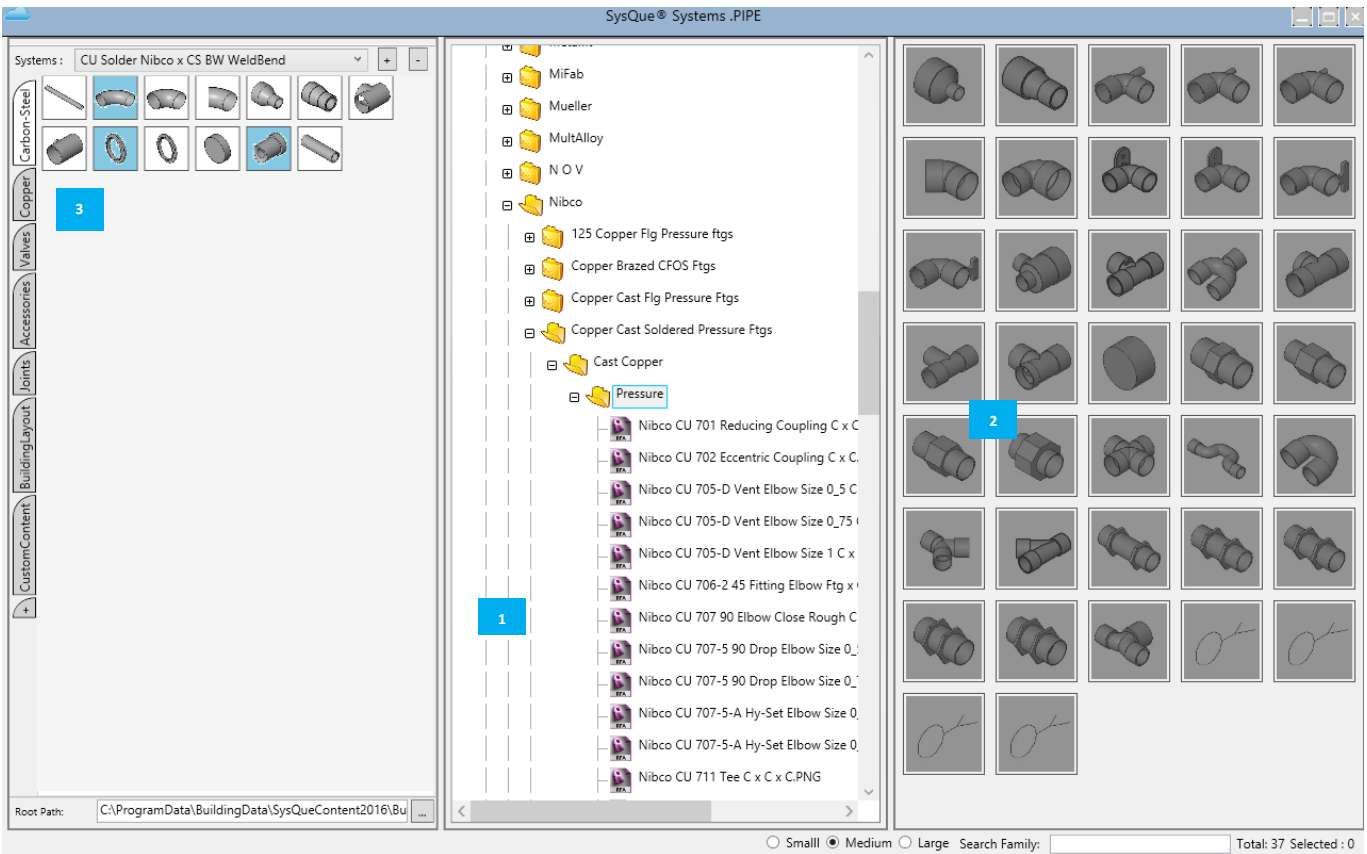

1 Follow your folder structure to locate your current System.



2 These are the systems available in your folder structure that you can add into your current working palette.

3 These are your current systems. Notice there are less here than in your folder structure.

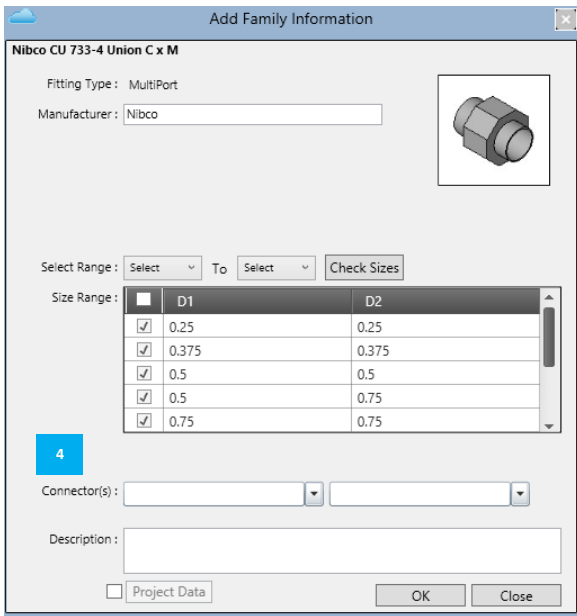

Drag and drop the fitting you would like to place in your current working palette.

4 Insert your relevant Fitting Information here like the size range, connectors, and a description.

Your fitting has been added successfully. You can close out of your Add Fittings menu and find the new fitting in your working palette.

Modeling Using SysQue Systems Pipe

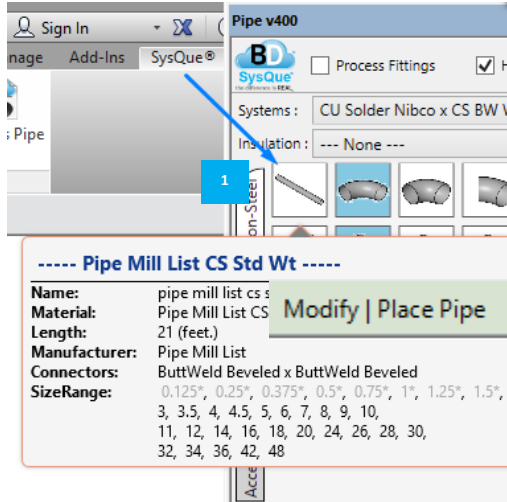

1 Draw a line of Pipe using the selected system, click on the button for Straight Pipe in the SysQue® Systems Pipe system window.

Across the top of the modeling area appears a new properties bar. Of particular interest are two items, the Diameter textboxes 2 and the Offset combo box 3

box
one of these sizes will place that size in the Diameter box above and the list to disappear. You can also type in any size you wish, and the system will automatically round that number to the closest size in the list.



Diameter – Clicking on the down arrow in the Diameter selection causes a list of predetermined pipe diameters to appear. Clicking on

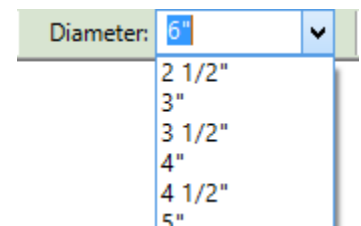

Offset – The Offset combo box allows you to set the elevation of the Pipe you are drawing relative to the height of the floor (or Reference Level) you are working on. A down arrow next to it allows you to select elevations previously input.

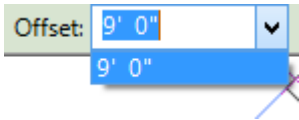

Once you have clicked on the straight Pipe in the “SysQue® Systems” window for Pipe and selected your width, height, and offset, start your Pipe run by left-clicking in the modeling field and pulling your mouse in the direction you wish your Pipe to run. (In the below example, the Pipe is being drawn to the east 35'-0".) Left-click again to set the end of the run at that point.

1. To continue drawing your Pipe run, move the mouse according to the direction and distance necessary, left-clicking at each change in direction.

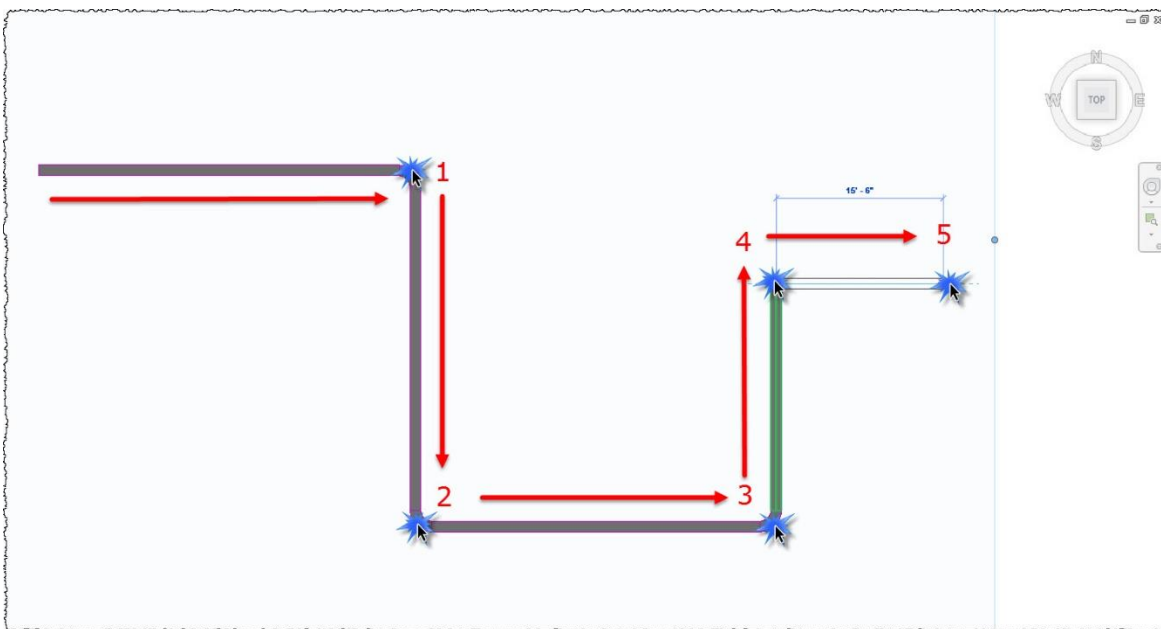
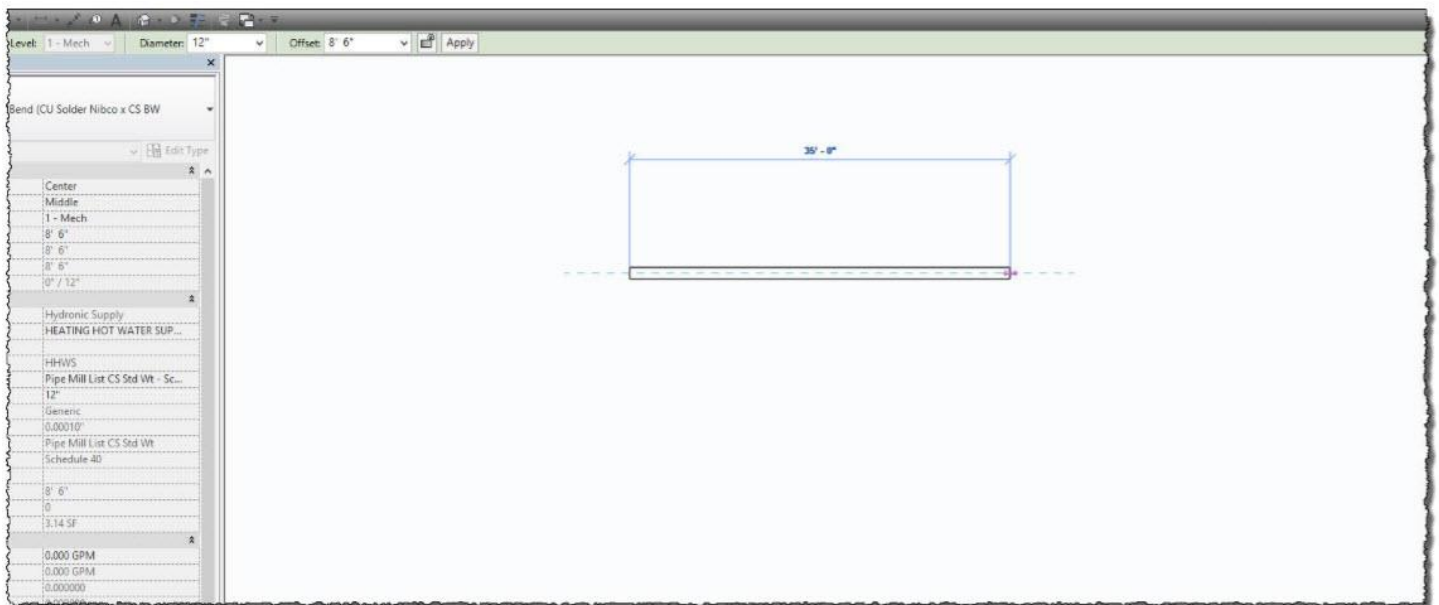

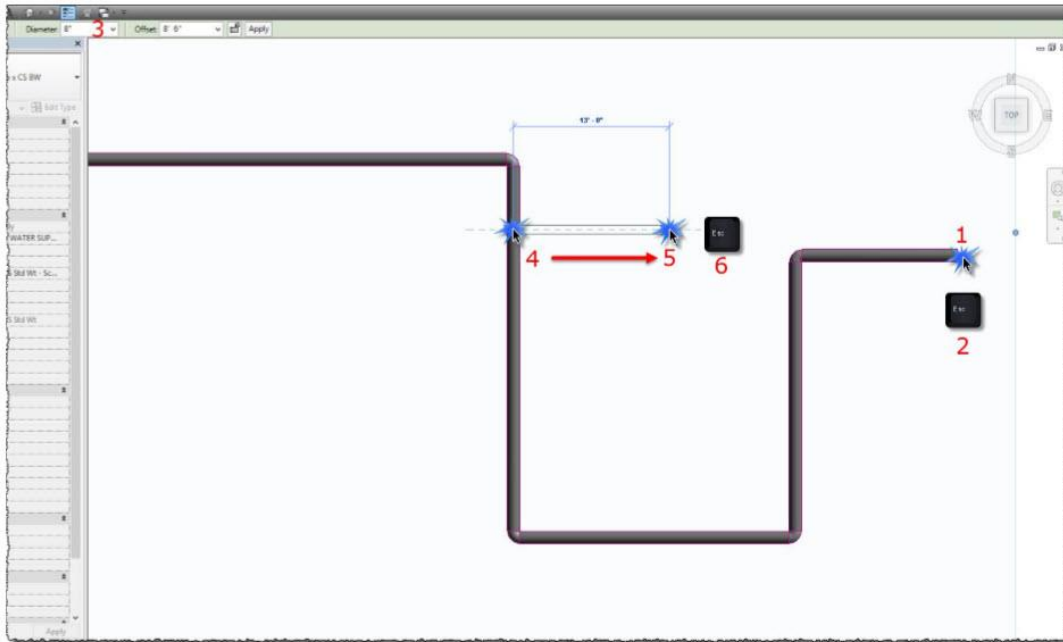

2. To add a branch, end your current run by left-clicking to set the terminus of your final Pipe and pressing the [ESC] key once. Change your Pipe width and height to the size of the branch. Move your mouse back over the section of Pipe you wish to attach to

and left-click. Run out the direction and distance you want your branch to lead. Finally, left-click and press the [ESC] key once to end the run.

3. To end your current run and continue in a new location, left-click to set the terminus of your final Pipe run, and press the [ESC] key once. Then, move to the new location, left click, and continue as before.

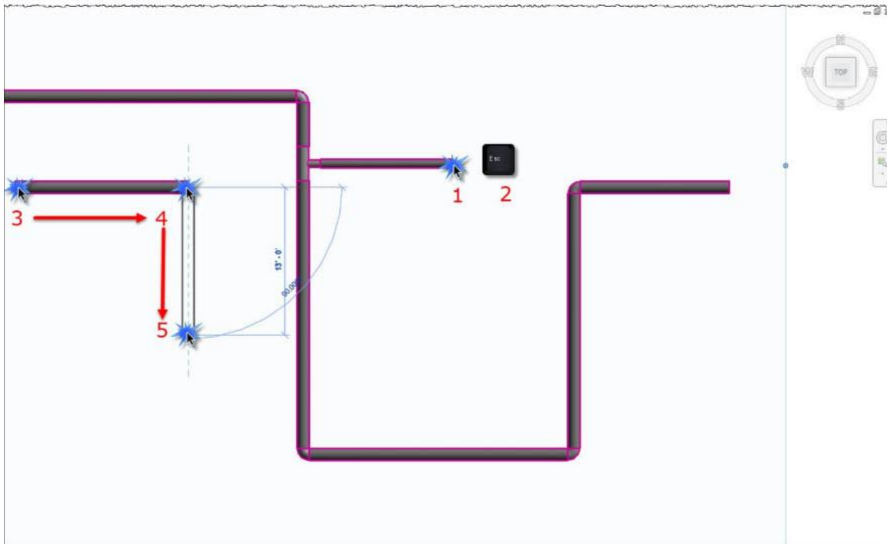

4. To end your run and stop drawing Pipe, left-click to set the terminus of your final Pipe run, and press the [ESC] key twice.

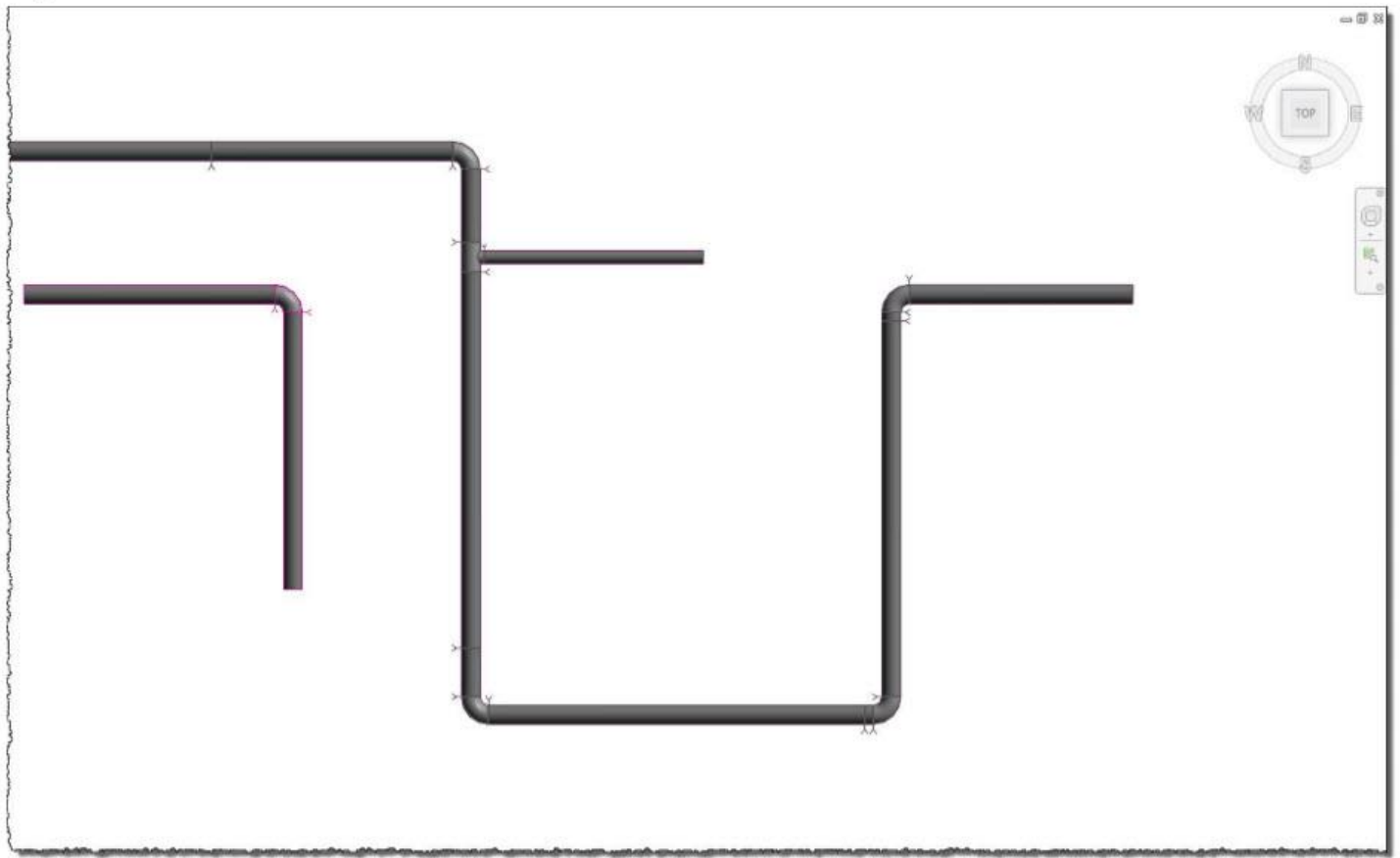

At this point, SysQue® will calculate fittings and pipe lengths, divide runs, and input couplings as necessary. It will also automatically begin to load the appropriate families into the model. When complete, you will have a live and accurate piping model from which you can order parts and create spools.

SysQue Connect

Users can attach and rotate pipe fittings easily. Works great for tight mechanical rooms with many back to back fittings with multiple rotations and helps quickly put together complex plumbing riser stacks.

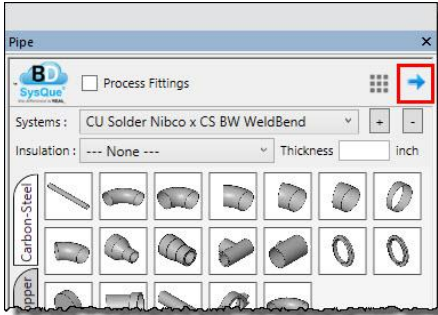

1) To draw with the connector first draw a piece of pipe then select the SysQue® Connect icon.

2) After selecting the connector arrow, you will be returned to your project with the arrow activated. Connect the arrow to the side of pipe

you want to take off from. Once this is done the “Select Rotation

Angle” box pops up. Choose your desired angle. You can manually insert your angle in the “Angle” Box or drag the arrow to your desired position.

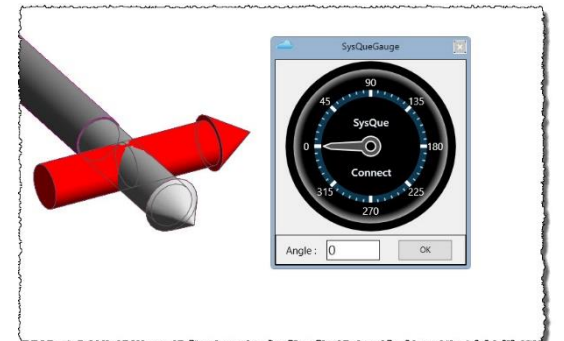
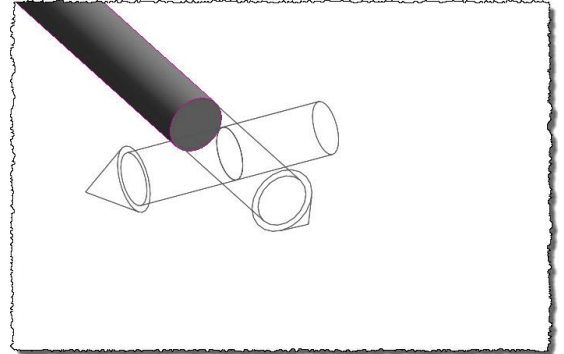
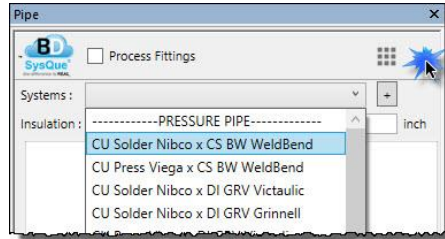

3) Once you have selected your desired angle press ok. Your SysQue® Systemes will come back and then choose which fitting you would like to connect. Grayed out fittings won't place with the arrow. We are continuing to add more and more with updates. You can repeat this as much as you like until you are complete. If you wish to connect a straight piece of pipe, simply left clicking with your mouse will place the standard length you have set. But if you right click the straight and select “Take off by length”. This will allow you to manually insert the length you would like, in inches.

